

Low voltage

Easy9

Catalogue 2019

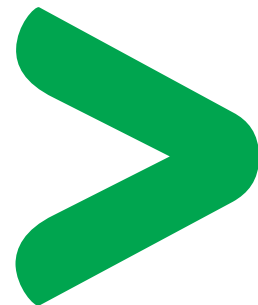

Schneider
Electric

Easy9

Affordable switchgear
you can depend on



Schneider
Electric™

Easy9

Content

Introduction	4
Easy 9 Overview	4
Example of Easy9 electrical panel	6
Circuit protection	7
Miniature circuit breakers	7
Selection guide	8
MCB 6000 A	9
MCB 10000 A	10
Characteristics, dimension & weight	11
RCBO – Residual Current devices	12
Earth leakage protection	14
Residual current devices	14
Selection guide	15
RCCB 2P / 4P Functions	16
Characteristics & dimensions	17
Switch-disconnectors	18
Characteristics, dimensions and weight	19
Comb busbars	20
Distribution Board	21
Vertical Busbar distribution board	21
Split Busbar distribution board	21
Characteristics & dimensions	23
ROW Distribution board	27
Index	28

Easy9

Affordable switchgear
you can depend on

A complete range of modular devices



Just what you want from switchgear

We work closely and constantly with electricians worldwide, helping to bring safe electricity to homes and small buildings around the globe. Now you can take pride in delivering to your customers the enhanced safety and peace of mind they deserve.

*“I would recommend Easy9
to anyone”*

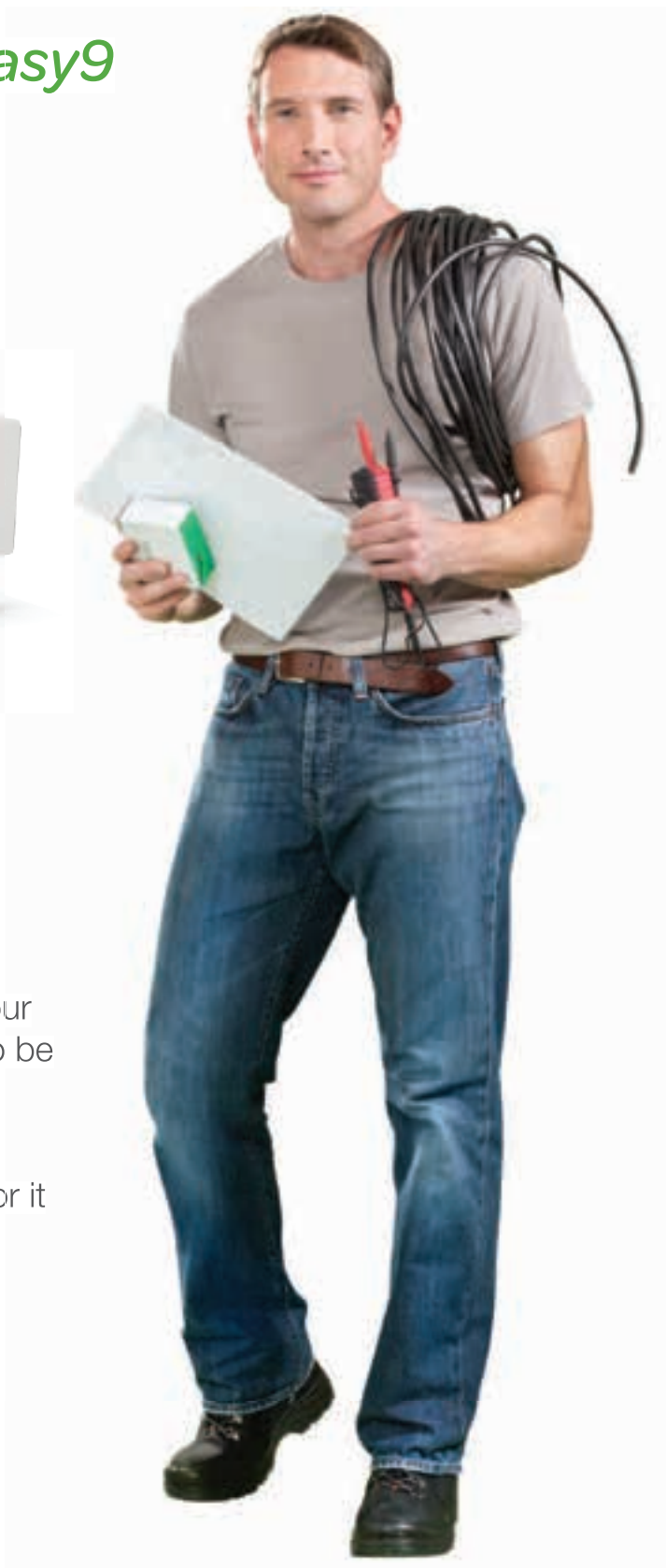

New, robust switchgear from
a brand you trust

The new Easy9 range better supports your business as an electrician, helping you to be more effective through:

- > A high-quality, user-friendly design
- > Availability when and where you look for it
- > High reliability at a price you can afford

Easy9

Example of Easy9 electrical panel

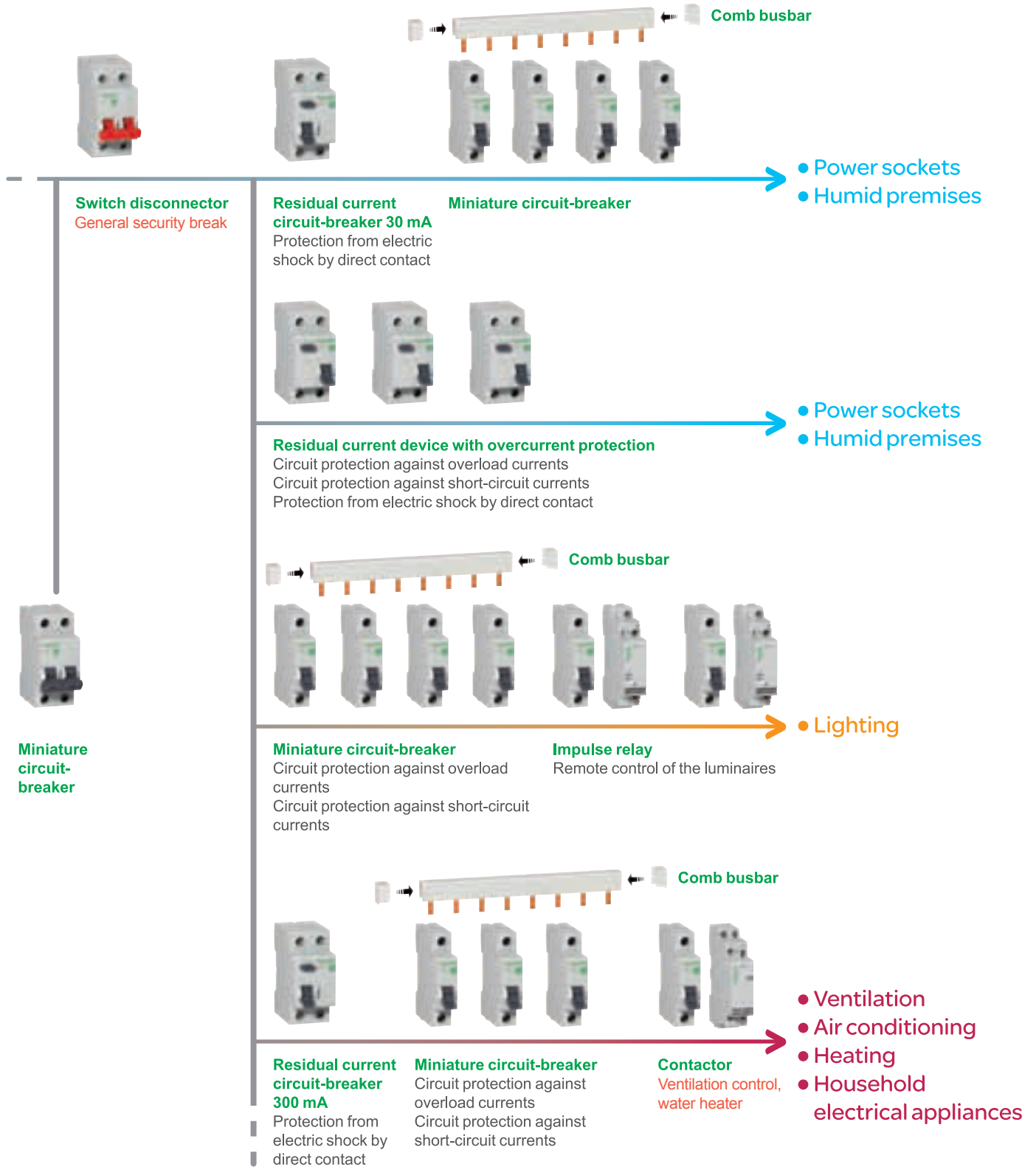

Easy9

Circuit protection



Miniature circuit breakers

Function

- Protection from short-circuits.
- Protection of cable from overload.







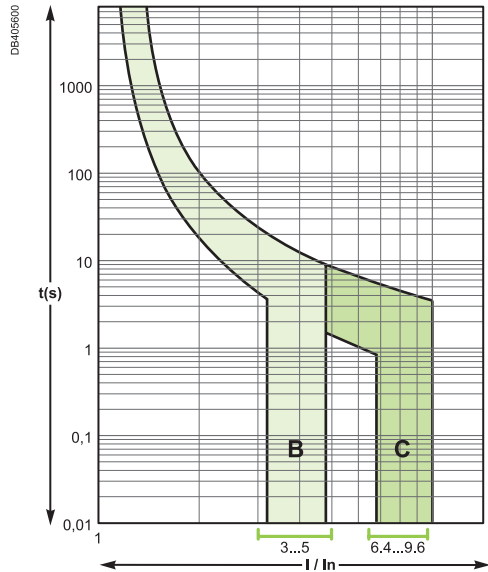





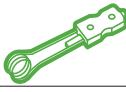

Selection of circuit breakers according to the cables to be protected (IEC 60364-5-52)

- PVC-insulated, copper, flexible or rigid cable.
- Ambient temperature:
 - 30°C in the open air (methods A, B, C, E)
 - 20°C if buried (method D),
- For other situations, refer to IEC 60364 standard (or equivalent national wiring rules in force).

Time current tripping curves



MCB selection chart for household appliances / office requirements

Appliance	Capacity	MCB rating (A)	Tripping curves
Air conditioner 	1 ton	16	"C"
	1.5 ton	20	
	2 ton	20	
	3 ton	25	
Refrigerator 	165 liters	2	
	285 liters	2	
Water heater 	1 kW	6	"B"
	3 kW	16	
Geyser 	4 kW	20	
	6 kW	32	
Electric kettle 	1.5 kW	10	
Nixie (50 % load) 	200 W	1	"C"
Vacuum cleaner 	50 W	0.5	
Toaster 	1.2 kW	6	"B"
Cooking range 	750 W	4	
	2 kW	10	
	4.5 kW	25	
Room heater 	1 kW	6	
	2 kW	10	
Washing machine 	300 W	2	"C"
	1.3 kW	10	
Electric iron 	750 W	6	"B"
	1.25 kW	6	
Photocopier 	1.5 kW	10	"C"
Mini water cooler (10 Liters/HR) 	500 W	3	

Easy9

Miniature circuit breaker 6000 A



PB11296-35



PB11300-35



PB11301-35



PB11302-35



1P

Circuit breakers	
Rating (In)	Curve C
6 A	EZ9F56106
10 A	EZ9F56110
16 A	EZ9F56116
20 A	EZ9F56120
25 A	EZ9F56125
32 A	EZ9F56132
40 A	EZ9F56140
50 A	EZ9F56150
63 A	EZ9F56163
Width in 9-mm modules	2

2P

Circuit breakers	
Rating (In)	Curve C
6 A	EZ9F56206
10 A	EZ9F56210
16 A	EZ9F56216
20 A	EZ9F56220
25 A	EZ9F56225
32 A	EZ9F56232
40 A	EZ9F56240
50 A	EZ9F56250
63 A	EZ9F56263
Width in 9-mm modules	4

3P

Circuit breakers	
Rating (In)	Curve C
6 A	EZ9F56306
10 A	EZ9F56310
16 A	EZ9F56316
20 A	EZ9F56320
25 A	EZ9F56325
32 A	EZ9F56332
40 A	EZ9F56340
50 A	EZ9F56350
63 A	EZ9F56363
Width in 9-mm modules	6

4P

Circuit breakers	
Rating (In)	Curve C
6 A	EZ9F56406
10 A	EZ9F56410
16 A	EZ9F56416
20 A	EZ9F56420
25 A	EZ9F56425
32 A	EZ9F56432
40 A	EZ9F56440
50 A	EZ9F56450
63 A	EZ9F56463
Width in 9-mm modules	8

Certified compliant IEC 60898-1

Additional feature

According to IEC 60898-1

Breaking capacity (Icn)	127 V AC	230 V AC
Ph/N	127 V AC	230 V AC
Ph/Ph	230 V AC	400 V AC
	10000 A	6000 A

Additional characteristics

Endurance (O-C)	Electrical	4,000 cycles
	Mechanical	10,000 cycles
Operating temperature		-5°C to +60°C
Storage temperature		-40°C to +85°C

Connection

DB40607



Rigid copper cables

6 to 25 A	1 to 25 mm ²	Tightening torque: 2 N.m
32 to 63 A	1 to 35 mm ²	Tightening torque: 3.5 N.m

Flexible copper cables

6 to 25 A	1 to 16 mm ²	Tightening torque: 2 N.m
32 to 63 A	1 to 25 mm ²	Tightening torque: 3.5 N.m

Easy9

Miniature circuit breaker

10000 A

CE



1P

Circuit breakers

Rating (In)	Curve C
6 A	EZ9F51106
10 A	EZ9F51110
16 A	EZ9F51116
20 A	EZ9F51120
25 A	EZ9F51125
32 A	EZ9F51132
40 A	EZ9F51140
63 A	EZ9F51163
Width in 9-mm modules	2

3P

Circuit breakers

Rating (In)	Curve C
6 A	EZ9F51306
10 A	EZ9F51310
16 A	EZ9F51316
20 A	EZ9F51320
25 A	EZ9F51325
32 A	EZ9F51332
40 A	EZ9F51340
63 A	EZ9F51363
Width in 9-mm modules	6

Connection

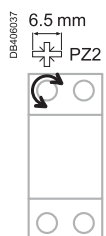

Rigid copper cables

6 to 25 A	1 to 25 mm ²	Tightening torque: 2 N.m
32 to 63 A	1 to 35 mm ²	Tightening torque: 3.5 N.m

Flexible copper cables

6 to 25 A	1 to 16 mm ²	Tightening torque: 2 N.m
32 to 63 A	1 to 25 mm ²	Tightening torque: 3.5 N.m

Certified compliant IEC 60898-1

Additional feature

According to IEC 60898-1

Breaking capacity (Icn)		
Ph/N	230 V AC	10000 A
Ph/Ph	400 V AC	10000 A
Use in direct current for 1P 63 A	60 V DC	5000 A

Additional characteristics

Endurance (O-C)	Electrical	4,000 cycles
	Mechanical	10,000 cycles
Operating temperature		-5°C to +60°C
Storage temperature		-40°C to +85°C

Miniature circuit breaker Characteristics, dimension & weight

Easy9 circuit breakers combine the following functions:

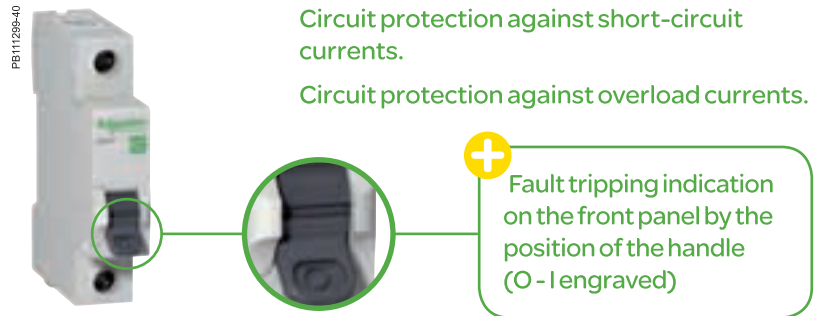

Characteristics

Main characteristics

Voltage rating (Ue)	230/400 V AC
Operating frequency	50/60 Hz
Electrical feeding	By the top and bottom

Additional characteristics

Degree of protection (IEC 60529)	Device only	IP20
	Device in modular enclosure	IP40
Hazardous substances	RoHS 2003 compliant	
Tropicalisation (IEC 60068-1)	Treatment 2 (relative humidity 95 % to 55°C)	

Dimensions (mm)

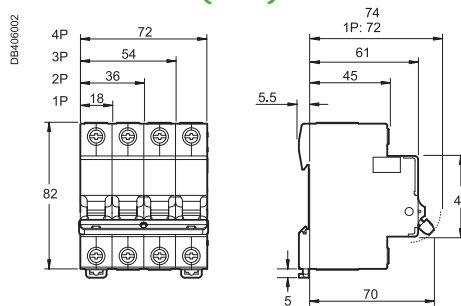

Weight (g)

Type	Easy9 MCB
1P	100
2P	205
3P	305
4P	405



Functions

- Protection from short-circuits.
- Protection of cable from overloads.
- Protection of persons from electric shocks by direct contact (30 mA sensitivity)
- Can be fitted instead of a miniature circuit breaker for complete protection of one circuit.

The neutral is not interrupted when the device is tripped. Hence Easy9 RCBO can be used on most circuits, except for the ones operating under TT or IT earthing systems.

1P+N_s

Easy9 RCBO type A  30 mA	
Rating (In)	C curve
6 A	EZ9D56806
10 A	EZ9D56810
16 A	EZ9D56816
20 A	EZ9D56820
25 A	EZ9D56825
32 A	EZ9D56832
40 A	EZ9D56840
45 A	EZ9D56845
Voltage rating (U _e)	220/240 V AC, 50 Hz
Width in 9-mm modules	2

Certified compliant IEC 61009-1 and IEC 61009-2-2



Characteristics

Main characteristics

Endurance (O-C)	Electrical	4,000 cycles
	Mechanical	10,000 cycles

Additional characteristics

Degree of protection	Device only	IP20
	Device in modular enclosure	IP40
Overvoltage category (IEC 60364)		IV
Operating temperature		-15°C to +60°C
Storage temperature		-40°C to +85°C
Hazardous substances		RoHS 2003 compliant
Tropicalisation (IEC 60068-1)		Treatment 2 (relative humidity 95 % to 55°C)

Connection

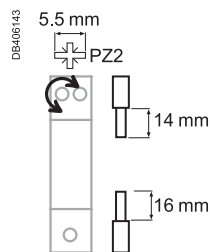

Rigid copper cables

L in	1 to 25 mm ²	Tightening torque: 2 N.m
L and N out	1 to 16 mm ²	Tightening torque: 2 N.m

Flexible copper cables

L in	1 to 16 mm ²	Tightening torque: 2 N.m
L and N out	1 to 10 mm ²	Tightening torque: 2 N.m

Dimensions (mm)

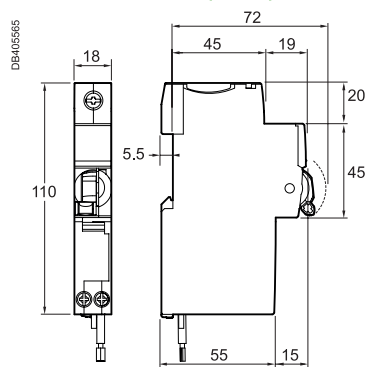

Weight (g)

Type	Easy9 RCBO
1P+N _s	180

Easy9

Earth leakage protection



Residual current devices

Function

- Protection of persons against electric shock by direct contact (30 mA).
- Protection of installations against the risk of fire (300 mA).
- Protection of persons against electric shock by indirect contact (100 mA ou 300 mA).

Operating principle

Protection from electric shocks by direct contact:

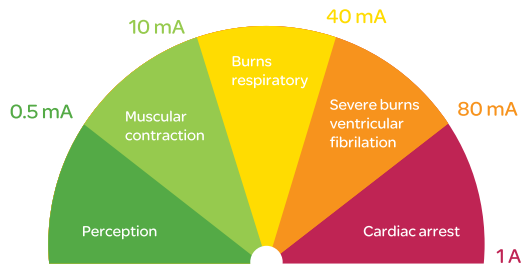

Research worldwide shows that the intensity of current flowing through the body determines the extent and severity of an electric shock.

- Injuries become serious when currents exceed 40 to 50 mA during one second.
- Theoretically, a 150 mA current flows through the body when a person touches a 230 V energised conductor under dry conditions.

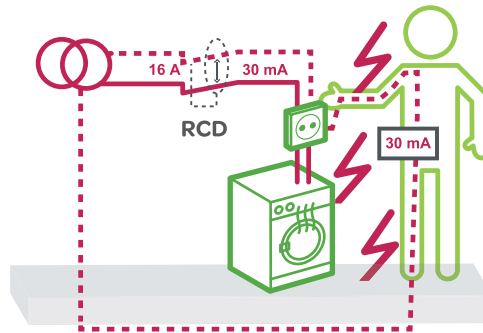

By measuring the intensity difference between live and neutral conductors, RCDs actually detect the current flowing through the human body. If this current reaches the 30 mA limit, the RC trips within a few milliseconds, so preventing injury or worse.

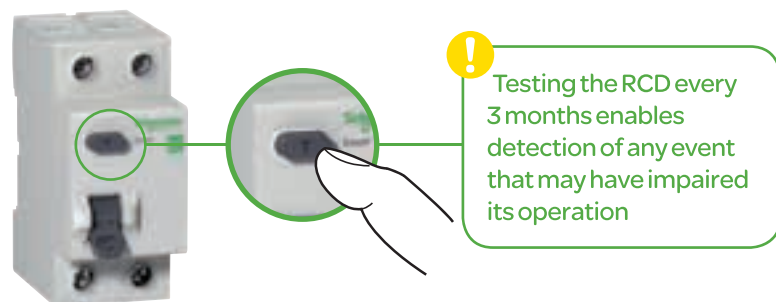

Check RCDs regularly

Test



Selection

Residual current sensitivity

Protection from	Residential	Non-residential	Sensitivity
 Electric shocks by direct contact	<ul style="list-style-type: none"> ■ Mandatory protection for all socket outlets ■ Mandatory protection for all electrical equipment in bathroom ■ Recommended for lighting circuits 	<ul style="list-style-type: none"> ■ Mandatory protection for all socket outlets ■ Mandatory protection for all equipment located ■ Close to water points 	<ul style="list-style-type: none"> ■ 30 mA ■ 10 mA for all applications where required by the standard (e.g.: jacuzzi, swimming pools, etc.)
 Fire ignited by leakage current	<ul style="list-style-type: none"> ■ Recommended in old buildings (presence of dust or moisture) 	<ul style="list-style-type: none"> ■ Mandatory in all locations under risk of fire or explosion ■ Recommended in all premises under presence of dust, moisture, chemical agents... 	<ul style="list-style-type: none"> ■ 300 mA
 Electric shock by indirect contact	<ul style="list-style-type: none"> ■ All circuits in case of "TT" earthing system 	<ul style="list-style-type: none"> ■ All circuits in case of "TT" earthing system 	<ul style="list-style-type: none"> ■ 100 mA or 300 mA



Current rating: shall not be in excess of upstream MCB current rating

Requirements from wiring regulation (.....)

Protection by means of a residual current protective device (RCD), shall be provided for:

- Socket outlets with a rated current not exceeding 20 A, that are for ordinary persons and intended for general use, mobile equipment with a current rating not exceeding 32 A for use outdoors.
- In rooms containing a bath or a shower.

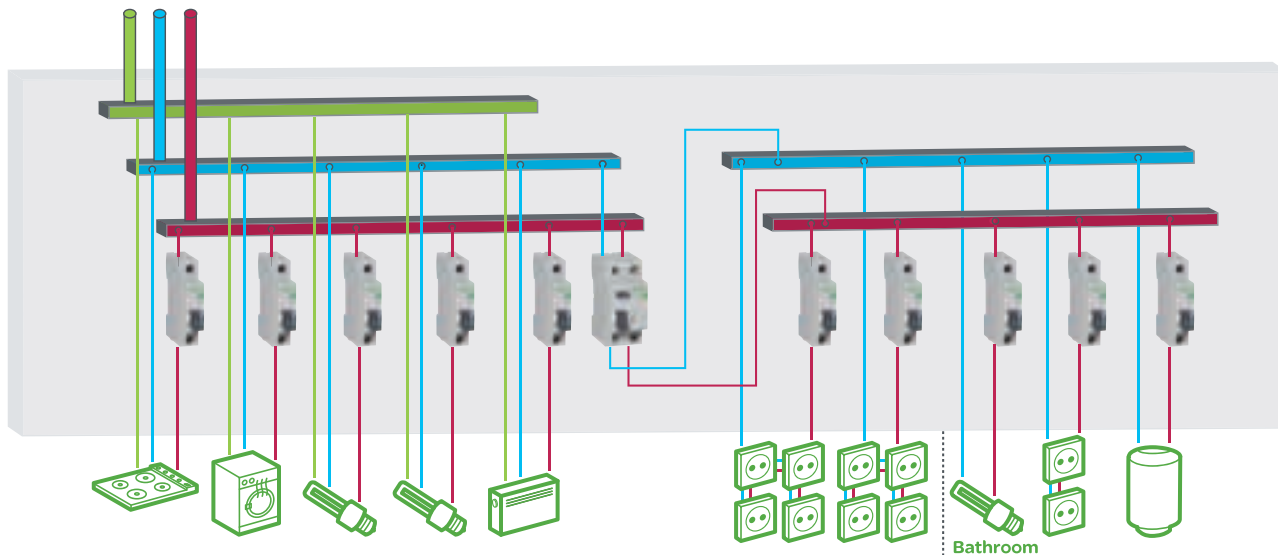

To comply with the regulation, just one RCD can protect all sockets and all bathroom equipment.

Easy9

RCCB residual current circuit breakers

2P / 4P Functions

CE

Functions

- Tripping in case of leakage current only.
- One RCCB protects several circuits when fitted upstream a group of circuit breakers.



2P

Residual current circuit breakers AC			
Rating (In)	30 mA	100 mA	300 mA
40 A	EZ9R36240	EZ9R56240	EZ9R66240
63 A	EZ9R36263	EZ9R56263	EZ9R66263
Voltage rating (Ue)	230 V, 50/60 Hz		
Width in 9-mm modules	4		

4P

Residual current circuit breakers AC			
Rating (In)	30 mA	100 mA	300 mA
40 A	EZ9R36440	EZ9R56440	EZ9R66440
63 A	EZ9R36463	EZ9R56463	EZ9R66463
Voltage rating (Ue)	400 V, 50/60 Hz		
Width in 9-mm modules	8		

Weight (g)

Type	Easy9 RCCB
2P	195
4P	375

Certified compliant IEC 61008-1

Additional feature

Endurance (O-C)	Electrical	2000 cycles
	Mechanical	5000 cycles
Conditional rated short circuit current (Inc/IΔc)	With fuse	6000 A
	With Easy9 MCB	6000 A
Operating temperature	-5°C to +60°C	
Storage temperature	-40°C to +85°C	
Electrical feeding	By the top and the bottom	

RCCB residual current circuit breakers

Characteristics and dimensions

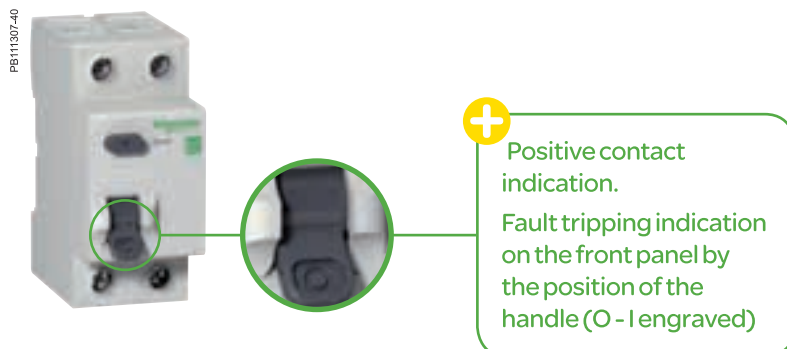

Characteristics

Main characteristics

Rated impulse withstand voltage (U _{imp})	4 kV
---	------

According to IEC 61008-1

Making and breaking capacity (I _m /I _{Δm})	500 A
---	-------

Additional characteristics

Degree of protection (IEC 60529)	Device only	IP20
	Device in modular enclosure	IP40
Hazardous substances	RoHS 2003 compliant	
Tropicalisation (IEC 60068-1)	Treatment 2 (relative humidity 95 % to 55°C)	

Connection

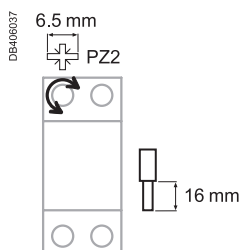

Rigid copper cables

1 to 35 mm ²	Tightening torque: 3.5 N.m
-------------------------	----------------------------

Flexible copper cables

1 to 25 mm ²	Tightening torque: 3.5 N.m
-------------------------	----------------------------

Dimensions (mm)

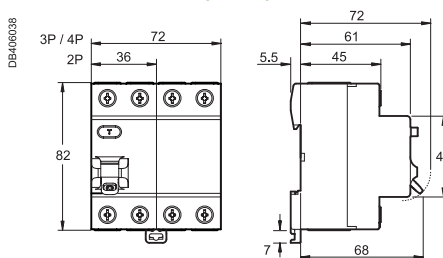

Easy9

Local control



Switch-disconnectors



Functions

The switch-disconnectors are used for:

- Control (opening and closing of circuits under load).
- Disconnection of on-load electrical circuits already protected against overloads and short-circuits.

1P

Easy9 control switches

Rating (Ie)	
40 A	EZ9S16140
63 A	EZ9S16163
100 A	EZ9S16191
125 A	EZ9S16192
Voltage rating (Ue)	230 V, 50/60 Hz
Width in 9-mm modules	2

2P

Easy9 control switches

Rating (Ie)	
40 A	EZ9S16240
63 A	EZ9S16263
100 A	EZ9S16291
125 A	EZ9S16292
Voltage rating (Ue)	400 V, 50/60 Hz
Width in 9-mm modules	4

3P

Easy9 control switches

Rating (Ie)	
40 A	EZ9S16340
63 A	EZ9S16363
100 A	EZ9S16391
125 A	EZ9S16392
Voltage rating (Ue)	400 V, 50/60 Hz
Width in 9-mm modules	6

4P

Easy9 control switches

Rating (Ie)	
40 A	EZ9S16440
63 A	EZ9S16463
80 A	EZ9S16480
100 A	EZ9S16491
125 A	EZ9S16492
Voltage rating (Ue)	400 V, 50/60 Hz
Width in 9-mm modules	8

Certified compliant IEC 60947-3-1

Connection

DB406037



Rigid copper cables

≤ 50 mm² Tightening torque: 3.5 N.m

Flexible copper cables

≤ 35 mm² Tightening torque: 3.5 N.m

Comb busbars

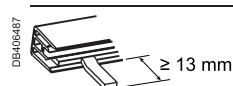

Switch-disconnectors

Characteristics, dimensions and weight

PB111313-40

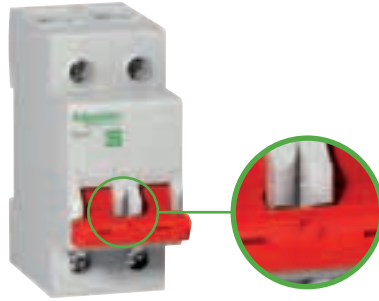

- + Position contact indication
- Suitable for industrial isolation according to IEC 60947-3 standard
- Manual control on front face by O-I lever

Characteristics

Main characteristics

Operating category	AC-22 A
Permissible rated short-time withstand current (I _{cw})	12 I _e , 1 seconde
Conditional rated short-circuit current (I _{nc})	5000 A
Rated short-circuit closing current (I _{cm})	15 I _e

Additional characteristics

Degree of protection (IEC 60529)	Device only	IP20	
	Device in modular enclosure	IP40	
Endurance (O-C)	Mechanical	40 -100 A	8500 cycles
		125 A	7000 cycles
	Electrical	40-100 A	1500 cycles
		125 A	1000 cycles
Operating temperature	-5°C to +55°C		
Storage temperature	-5°C to +70°C		
Tropicalisation (IEC 60068-1)	Treatment 2 (relative humidity 95 % to 55°C)		

Dimensions (mm)

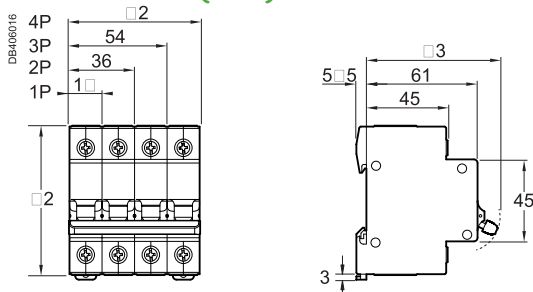

Weight (g)

Type	Easy9 switch-disconnectors
1P	90
2P	175
3P	260
4P	345

Easy9

Connection

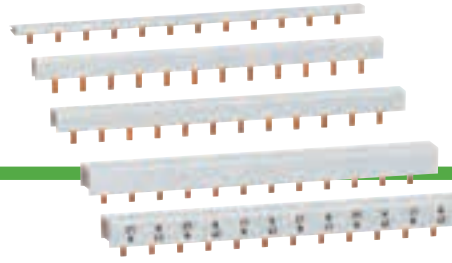

Comb busbars



Quality brands



Country approval pictograms

IEC 60439-1, IEC 60664.

Functions

The comb busbars:

- Ensure easy reliable mounting of switchgear: tooth positioning opposite the devices terminals is ensured by indexing of copper parts.
- Can be sawn and cut.
- Supplied with two IP20 lateral end-pieces, the end-pieces are compulsory.
- Unused teeth can be insulated with tooth covers.



Quick assembly and disassembly of the devices connected

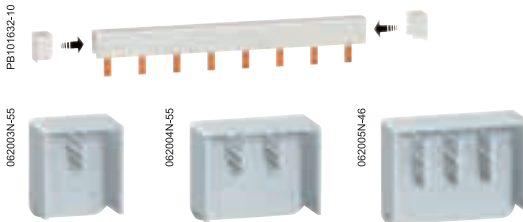
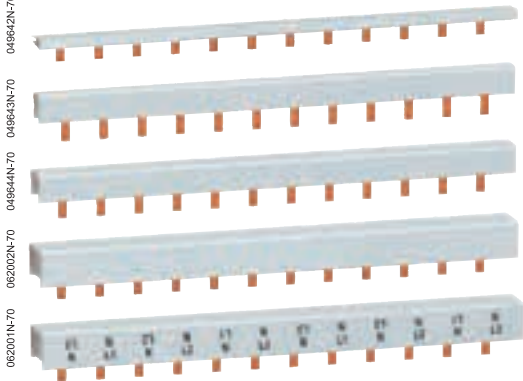

Comb busbars

Recuttable comb busbars

Type	Rating (A)	Width in mod. of 18 mm	Description	
1P	63	12	12 modules	10387
		57	1 m	10388
2P	63	12	12 modules	10389
		57	1 m	10390
3P	63	12	12 modules	10391
		57	1 m	10392
4P	63	12	12 modules	10393
		57	1 m	10394
L1N/L2N/L3N		57	1 m	10395

Accessories

Type	
1 set of 4, 35 mm ² connectors	10397
1 set of 10 bar end-pieces (2 phases)	10398
1 set of 10 bar end-pieces (3 phases)	10399
1 set of 10 bar end-pieces (4 phases)	10405
1 set of 10 tooth shields	10396

Characteristics

Main characteristics

Rated voltage (Ue)	Ph/N	230 V AC
	Ph/Ph	400 V AC
Insulation voltage (Ui)		500 V
Short-circuit current withstand		Compatible with the breaking capacity of Schneider Electric modular circuit breakers
Pollution degree		3
Fire resistance to IEC 60695-2-10		Self-extinguishing 850°C 30 s
Colour		RAL 7035
Power supply		By 16 mm ² semi-rigid or 10 mm ² flexible cable
		With connector

Flush or surface mounting distribution board

Description

Easy 9 distribution board consists of a range of metallic enclosures, it is specifically designed to accommodate Schneider Electric device outgoings modular "DIN"(MCB & RCBO) for protection of people and equipment and wide choice of incomers (MCB, RCCB, switch disconnector).

- Plain flat door with sliding knob to enable easy and safe opening and closing of door.
- Common references for surface and flush along with plastering guide on side of the distribution board to enable easy alignment for flush mounting.
- Top and bottom removable gland plates with precut cable passthroughs.
- Earth and neutral terminal blocks.

Single phase distribution board

- Available from 6, 8, 10, 12 and 16 ways with fixed busbar (excluding main incomer).

- Incomer provision:
 - 2P, isolator 40 to 100 A,
 - 2P, RCCB upto 100 A,
 - 2P, MCB upto 63 A.
- Outgoer provision: MCB.

Single phase distribution board

Number of way	Rated current In (A)	Cat n°	Terminal block (number of holes)	
			Earth terminals	Neutral terminals
6	100	EZ9ES6L	7	6 + 1
8	100	EZ9ES8L	10	10 + 1
10	100	EZ9ES10L	10	10 + 1
12	100	EZ9ES12L	18	16 + 1
16	100	EZ9ES16L	18	16 + 1



Vertical 3 phase distribution board Straight with Fixlink

- Available in 12, 18, 24, 30, 36 and 42 ways (excluding main incomer).
- Straight busbar distribution board with Fixlink.
- Incomer provision: isolator: upto 125 A.
- Outgoer provision: MCB, RCBO.

Vertical 3 phase distribution board Straight with Fixlink

Number of way	Rated current In (A)	Cat n°	Terminal block (number of holes)	
			Earth terminals	Neutral terminals
12	125	EZ9ET12L	12 + 2	12 + 2
18	125	EZ9ET18L	18 + 2	18 + 2
24	125	EZ9ET24L	24 + 2	24 + 2
30	125	EZ9ET30L	30 + 2	30 + 2
36	125	EZ9ET36L	36 + 2	36 + 2
42	125	EZ9ET42L	42 + 2	42 + 2



Vertical 3 phase distribution board Split

Available in 6+6, 6+12, 12+12, 12+18, 12+24 12+30, 18+18, 18+24 ways (excluding main incomer).

- Straight busbar distribution board with Fixlink.
- Incomer provision: : upto two 4P RCCB and one 4P isolator
- Outgoer provision: MCB.

Vertical 3 phase distribution board Split

Number of way	Rated current In (A)	Cat n°	Terminal block (number of holes)	
			Earth terminals	Neutral terminals
6+6	125	EZ9EP66	14	8 and 8
6+12	125	EZ9EP612	20	8 and 14
12+12	125	EZ9EP1212	26	14 and 14
12+18	125	EZ9EP1218	32	14 and 20
12+24	125	EZ9EP1224	38	14 and 26
12+30	125	EZ9EP1230	44	14 and 32
18+18	125	EZ9EP1818	38	20 and 20
18+24	125	EZ9EP1824	44	20 and 26

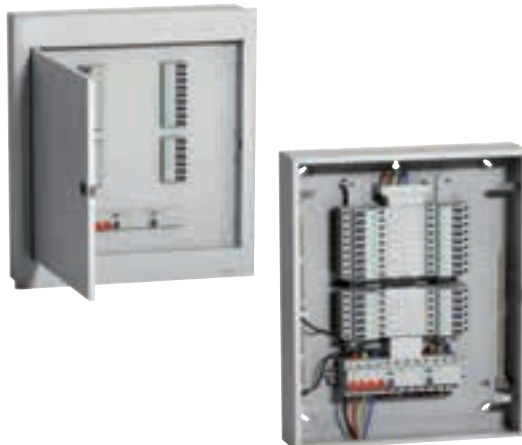

Split Busbar distribution board

PB115528-40



PB115529-40



PB115530-40



Vertical 3 phase distribution board Split

Available in 6+6, 6+12, 12+12, 12+18, 12+24 12+30, 18+18, 18+24 ways (excluding main incomer).

- Straight busbar distribution board with Fixlink.
- Incomer provision: : upto two 4P RCCB and one 4P isolator
- Outgoer provision: MCB.

Vertical 3 phase distribution board Split

Number of way	Rated current In (A)	Cat n°	Terminal block (number of holes)	
			Earth terminals	Neutral terminals
6+6	125	EZ9EP66	14	8 and 8
6+12	125	EZ9EP612	20	8 and 14
12+12	125	EZ9EP1212	26	14 and 14
12+18	125	EZ9EP1218	32	14 and 20
12+24	125	EZ9EP1224	38	14 and 26
12+30	125	EZ9EP1230	44	14 and 32
18+18	125	EZ9EP1818	38	20 and 20
18+24	125	EZ9EP1824	44	20 and 26

Easy9

Flush or surface mounting distribution board

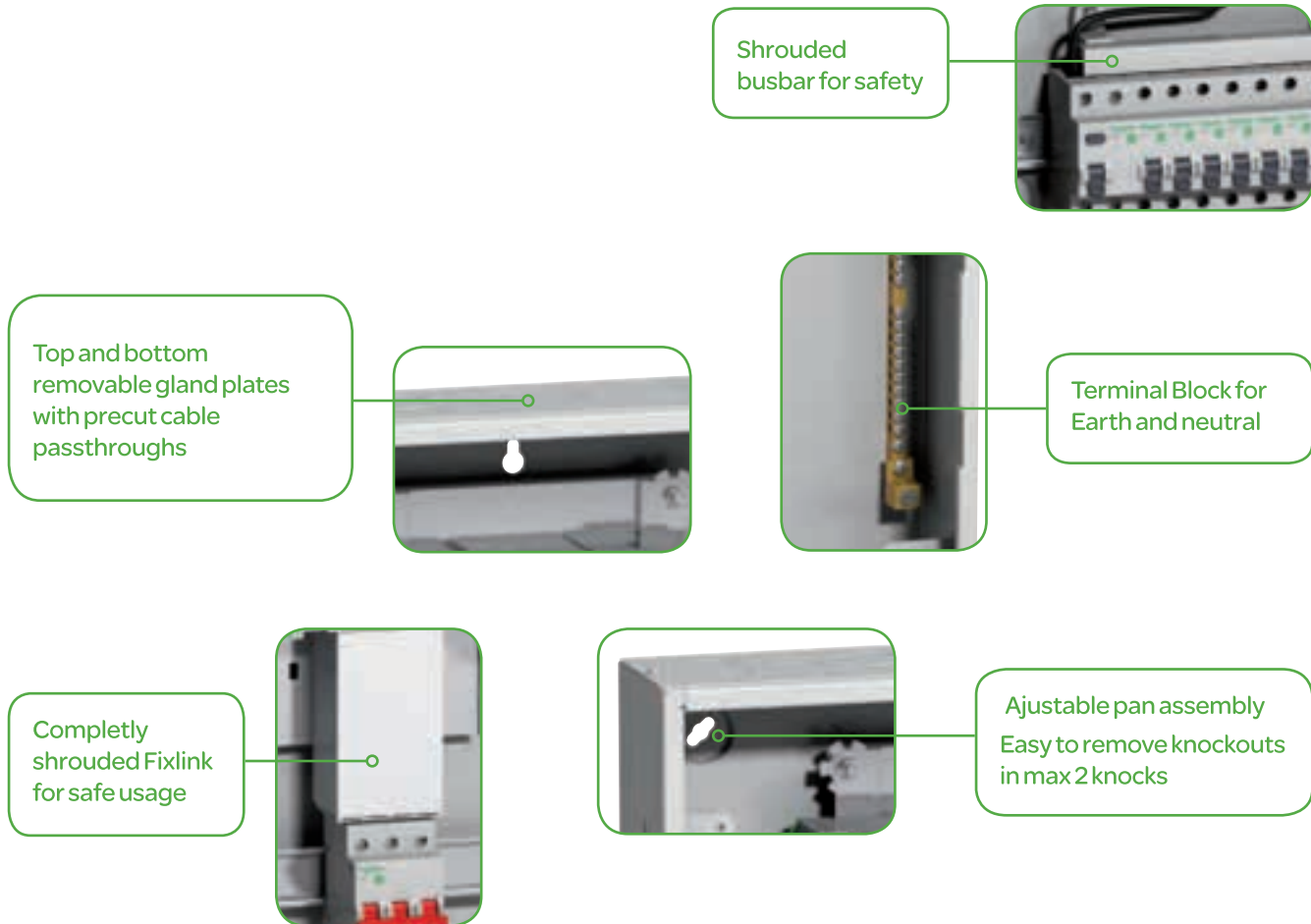

Characteristics

Main characteristics

Compliance with standards	IEC 61439-1, IEC 61439-3	
Rated current (In)	Single phase	100 A
	Vertical 3 phase	125 A
Permissible rated short-time withstand current (Icw)	Single phase	6 kA for 250 ms
	Vertical 3 phase	17 kA for 250 ms
Permissible peak current (Ipk)	Single phase	-
	Vertical 3 phase	34 kA
Operating voltage (Ue)	Single phase	230 V, 50 Hz
	Vertical 3 phase	400 V, 50 Hz

Additional characteristics

Degree of protection	To IEC 60529	IP40 closed door
	To IEC 62262	IK08 against mechanical impacts
Operating temperature	-25°C to +50°C	
Color	Grey RAL 7035	
Materials	Metal enclosure:	
	<ul style="list-style-type: none"> ■ CRCA 1.2 mm thick steel sheet ■ high quality epoxy polyester based powder surface coating. 	

Flush or surface mounting distribution board

Single phase distribution boards

Dimensions (mm)

Single phase distribution boards

DB406842

12/16 ways

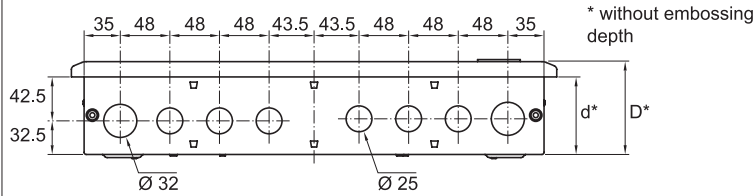

Ways	Product dimensions (H x W x D)	U box dimensions (h x w x d)
6 (2 + 6 ways)	290 x 232 x 90	265 x 224 x 75
8 (2 + 8 ways)	362 x 232 x 90	337 x 224 x 75
10 (2 + 10 ways)	362 x 232 x 90	337 x 224 x 75
12 (2 + 12 ways)	470 x 232 x 90	445 x 224 x 75
16 (2 + 16 ways)	470 x 232 x 90	445 x 224 x 75

8/10 ways

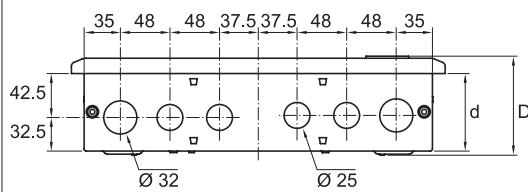

6 ways

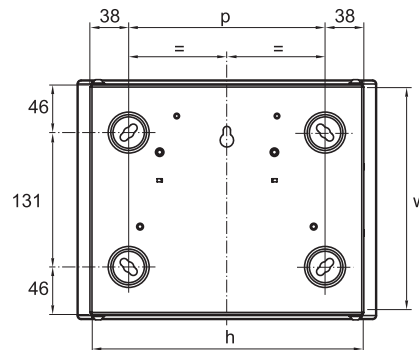
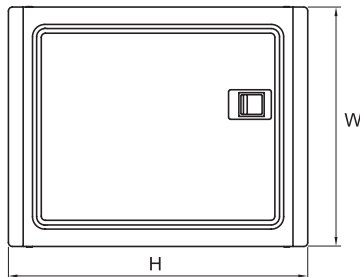
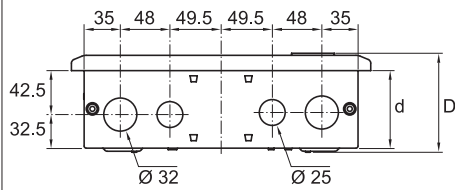

Ways	p
6 (2 + 6 ways)	190
8 (2 + 8 ways)	263
10 (2 + 10 ways)	263
12 (2 + 12 ways)	371
16 (2 + 16 ways)	371

Flush mounting view

DB406841

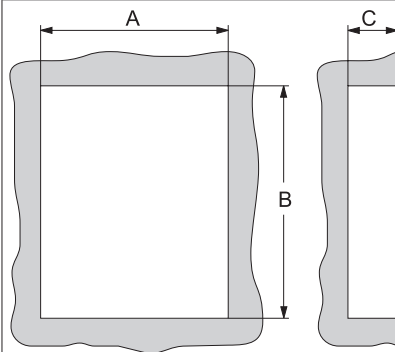

Ways	A	B	C
6	270	237	75
8	342	237	75
10	342	237	75
12	450	237	75
16	450	237	75

Flush or surface mounting distribution board

Vertical 3 phase distribution boards

Dimensions (mm)

Vertical 3 phase distribution boards

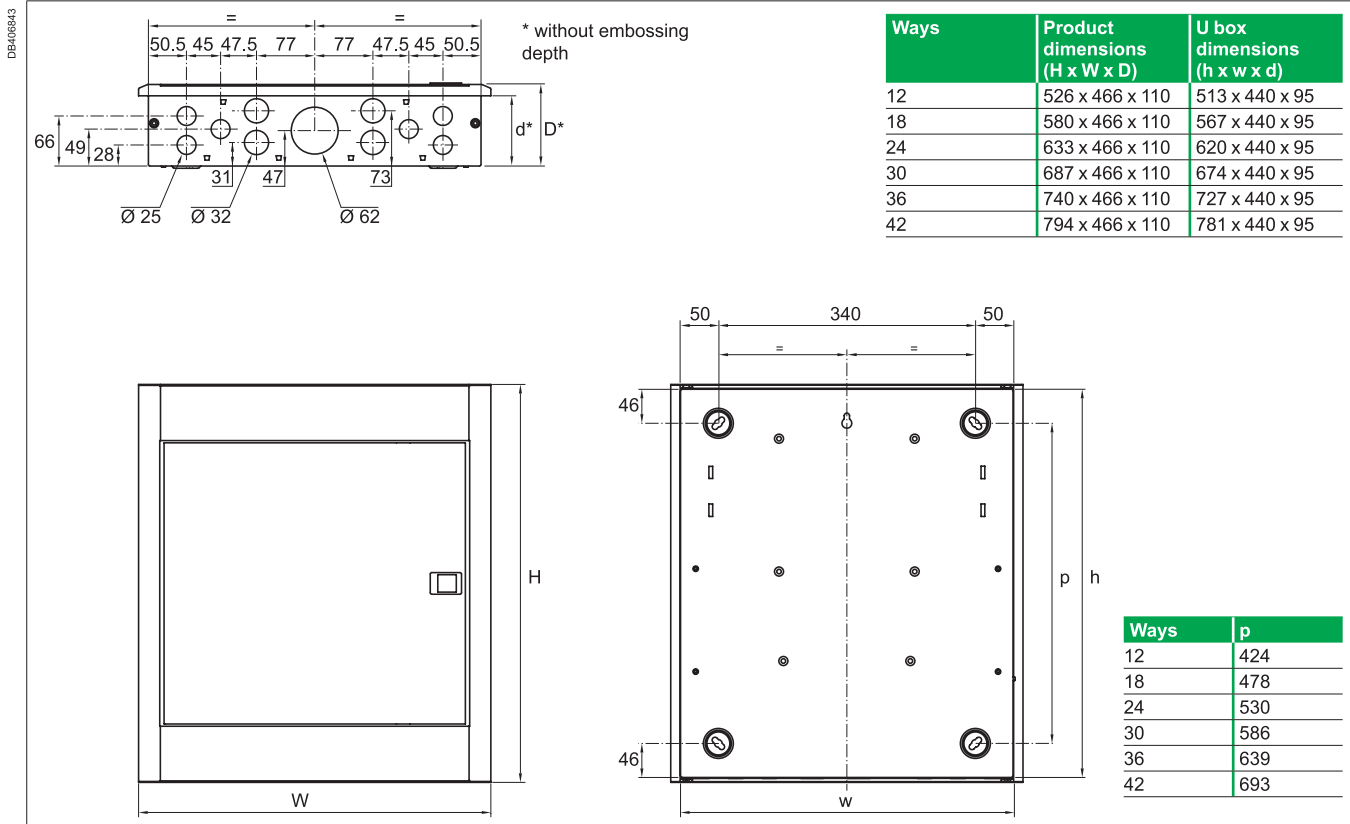

Flush mounting view

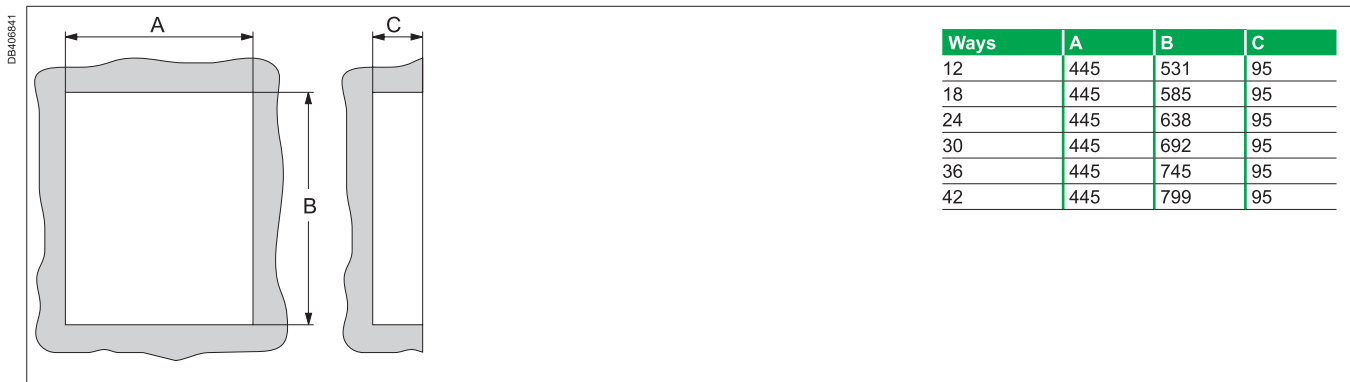

Flush or surface mounting split distribution board

Vertical 3 phase distribution boards

Dimensions (mm)

Vertical 3 phase distribution boards Split

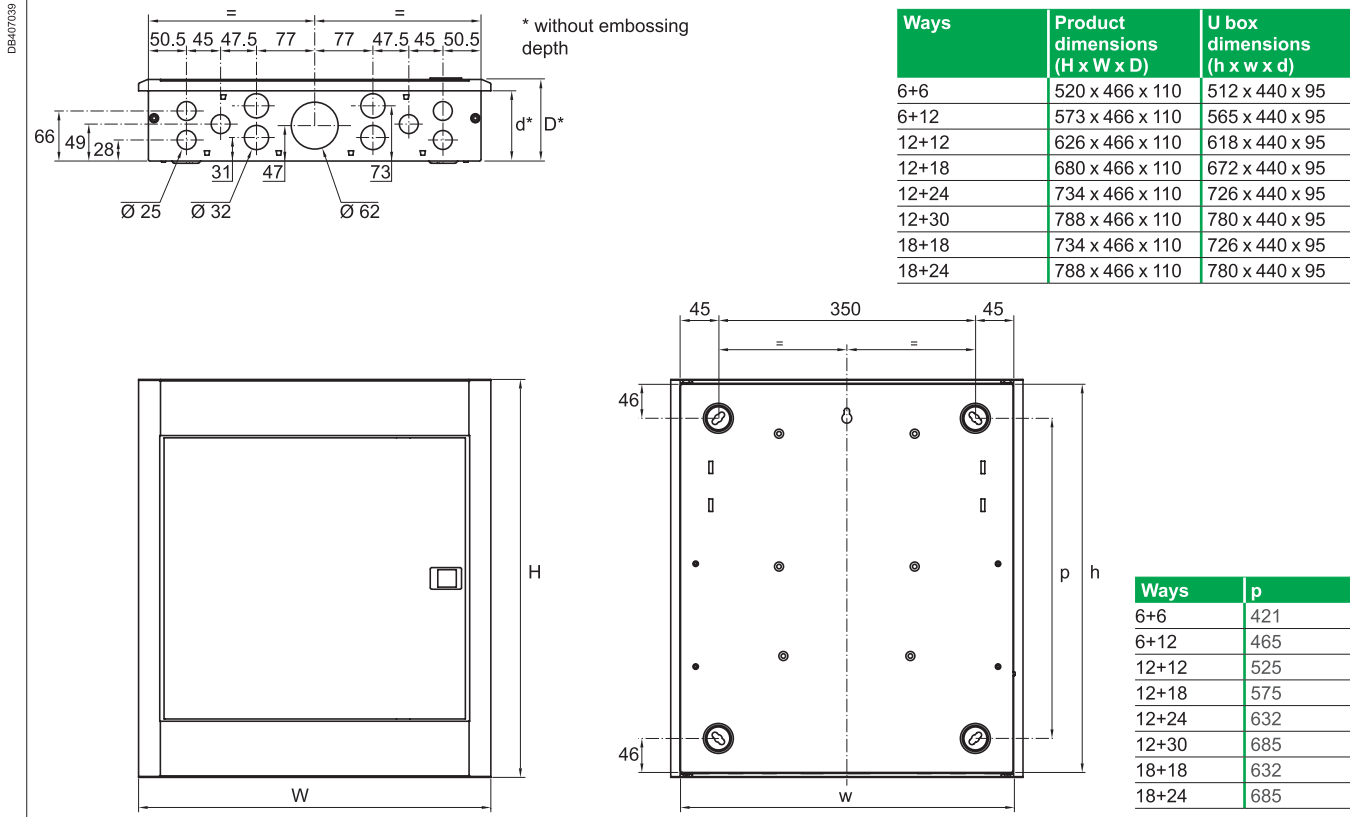

Flush mounting view

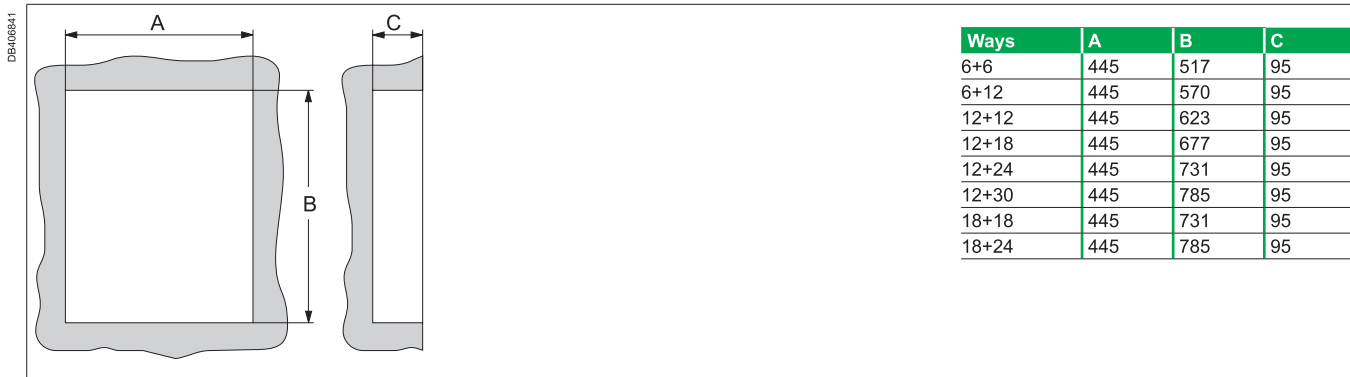



Technical data

Distribution board	
Standard	IEC61439-1&2
Electrogalvanized sheet thickness	1 mm
Color	RAL 7035
Number of module per row	16
Number of row	1 to 6

Define the ROW type distribution board you need

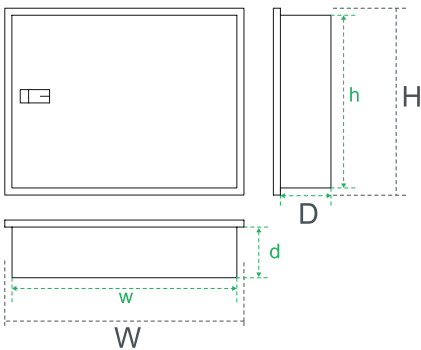
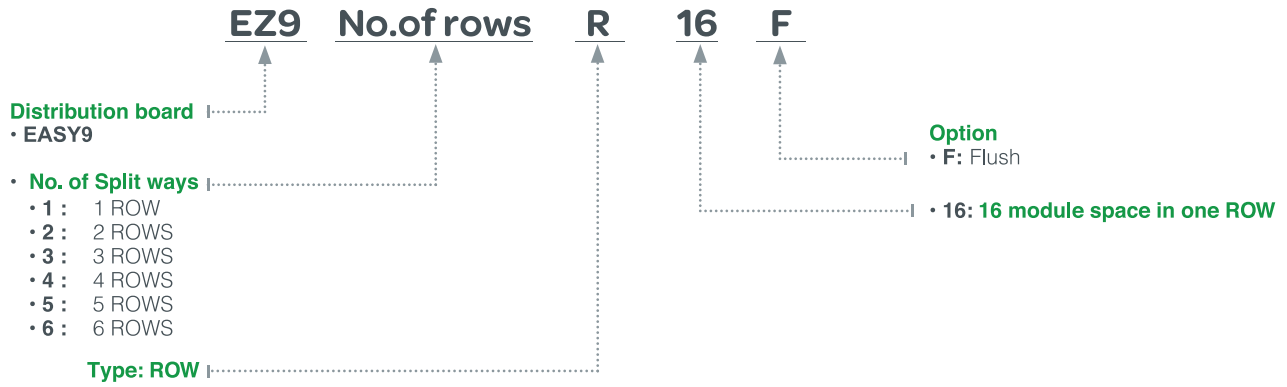

Catalogue Reference	Description	Number of SP ways	Dimensions (mm)					
			Outside			Wall		
			H	W	D	h	w	d
EZ91R16F	Easy9 1 Row 16 module Flush	16	295	425	118	270	400	117
EZ92R16F	Easy9 2 Rows 16 module Flush	32	445	425	118	420	400	117
EZ93R16F	Easy9 3 Rows 16 module Flush	48	595	425	118	570	400	117
EZ94R16F	Easy9 4 Rows 16 module Flush	64	745	425	118	720	400	117
EZ95R16F	Easy9 5 Rows 16 module Flush	80	895	425	118	870	400	117
EZ96R16F	Easy9 6 Rows 16 module Flush	96	1045	425	118	1020	400	117

Index

Product name	Description	Page
EZ9F56106	Easy9 MCB 1P 6A C 6000A 230V	9
EZ9F56110	Easy9 MCB 1P 10A C 6000A 230V	9
EZ9F56116	Easy9 MCB 1P 16A C 6000A 230V	9
EZ9F56120	Easy9 MCB 1P 20A C 6000A 230V	9
EZ9F56125	Easy9 MCB 1P 25A C 6000A 230V	9
EZ9F56132	Easy9 MCB 1P 32A C 6000A 230V	9
EZ9F56140	Easy9 MCB 1P 40A C 6000A 230V	9
EZ9F56150	Easy9 MCB 1P 50A C 6000A 230V	9
EZ9F56163	Easy9 MCB 1P 63A C 6000A 230V	9
EZ9F56206	Easy9 MCB 2P 6A C 6000A 230V	9
EZ9F56210	Easy9 MCB 2P 10A C 6000A 230V	9
EZ9F56216	Easy9 MCB 2P 16A C 6000A 230V	9
EZ9F56220	Easy9 MCB 2P 20A C 6000A 230V	9
EZ9F56225	Easy9 MCB 2P 25A C 6000A 230V	9
EZ9F56232	Easy9 MCB 2P 32A C 6000A 230V	9
EZ9F56240	Easy9 MCB 2P 40A C 6000A 230V	9
EZ9F56250	Easy9 MCB 2P 50A C 6000A 230V	9
EZ9F56263	Easy9 MCB 2P 63A C 6000A 230V	9
EZ9F56306	Easy9 MCB 3P 6A C 6000A 400V	9
EZ9F56310	Easy9 MCB 3P 10A C 6000A 400V	9
EZ9F56316	Easy9 MCB 3P 16A C 6000A 400V	9
EZ9F56320	Easy9 MCB 3P 20A C 6000A 400V	9
EZ9F56325	Easy9 MCB 3P 25A C 6000A 400V	9
EZ9F56332	Easy9 MCB 3P 32A C 6000A 400V	9
EZ9F56340	Easy9 MCB 3P 40A C 6000A 400V	9
EZ9F56350	Easy9 MCB 3P 50A C 6000A 400V	9
EZ9F56363	Easy9 MCB 3P 63A C 6000A 400V	9
EZ9F56406	Easy9 MCB 4P 6A C 6000A 400V	9
EZ9F56410	Easy9 MCB 4P 10A C 6000A 400V	9
EZ9F56416	Easy9 MCB 4P 16A C 6000A 400V	9
EZ9F56420	Easy9 MCB 4P 20A C 6000A 400V	9
EZ9F56425	Easy9 MCB 4P 25A C 6000A 400V	9
EZ9F56432	Easy9 MCB 4P 32A C 6000A 400V	9
EZ9F56440	Easy9 MCB 4P 40A C 6000A 400V	9
EZ9F56450	Easy9 MCB 4P 50A C 6000A 400V	9
EZ9F56463	Easy9 MCB 4P 63A C 6000A 400V	9
EZ9F51106	Easy9 1P 6A C MCB 10KA	10
EZ9F51110	Easy9 1P 10A C MCB 10KA	10
EZ9F51116	Easy9 1P 16A C MCB 10KA	10
EZ9F51120	Easy9 1P 20A C MCB 10KA	10
EZ9F51125	Easy9 1P 25A C MCB 10KA	10
EZ9F51132	Easy9 1P 32A C MCB 10KA	10
EZ9F51140	Easy9 1P 40A C MCB 10KA	10
EZ9F51163	Easy9 1P 63A C MCB 10KA	10
EZ9F51306	Easy9 3P 6A C MCB 10KA	10
EZ9F51310	Easy9 3P 10A C MCB 10KA	10
EZ9F51316	Easy9 3P 16A C MCB 10KA	10
EZ9F51320	Easy9 3P 20A C MCB 10KA	10
EZ9F51325	Easy9 3P 25A C MCB 10KA	10
EZ9F51332	Easy9 3P 32A C MCB 10KA	10
EZ9F51340	Easy9 3P 40A C MCB 10KA	10
EZ9F51363	Easy9 3P 63A C MCB 10KA	10
EZ9D56806	Easy9 1P-Ns 6A C 6000A 30mA AC RCBO	12
EZ9D56810	Easy9 1P-Ns 10A C 6000A 30mA AC RCBO	12
EZ9D56816	Easy9 1P-Ns 16A C 6000A 30mA AC RCBO	12
EZ9D56820	Easy9 1P-Ns 20A C 6000A 30mA AC RCBO	12
EZ9D56825	Easy9 1P-Ns 25A C 6000A 30mA AC RCBO	12
EZ9D56832	Easy9 1P-Ns 32A C 6000A 30mA AC RCBO	12
EZ9D56840	Easy9 1P-Ns 40A C 6000A 30mA AC RCBO	12
EZ9D56845	Easy9 1P-Ns 45A C 6000A 30mA AC RCBO	12
EZ9R36240	Easy9 RCCB 2P 40A 30MA AC-type 230V	16
EZ9R56240	Easy9 RCCB 2P 40A 100MA AC-type 230V	16
EZ9R66240	Easy9 RCCB 2P 40A 300MA AC-type 230V	16
EZ9R36263	Easy9 RCCB 2P 63A 30MA AC-type 230V	16
EZ9R56263	Easy9 RCCB 2P 63A 100MA AC-type 230V	16
EZ9R66263	Easy9 RCCB 2P 63A 300MA AC-type 230V	16
EZ9R36440	Easy9 RCCB 4P 40A 30MA AC-type 400V	16

Product name	Description	Page
EZ9R56440	Easy9 RCCB 4P 40A 100MA AC-type 400V	16
EZ9R66440	Easy9 RCCB 4P 40A 300MA AC-type 400V	16
EZ9R36463	Easy9 RCCB 4P 63A 30MA AC-type 400V	16
EZ9R56463	Easy9 RCCB 4P 63A 100MA AC-type 400V	16
EZ9R66463	Easy9 RCCB 4P 63A 300MA AC-type 400V	16
EZ9S16140	Easy9 Switch Disconnecter 1P 40A 230V	18
EZ9S16163	Easy9 Switch Disconnecter 1P 63A 230V	18
EZ9S16191	Easy9 Switch Disconnecter 1P 100A 230V	18
EZ9S16192	Easy9 Switch Disconnecter 1P 125A 230V	18
EZ9S16240	Easy9 Switch Disconnecter 2P 40A 400V	18
EZ9S16263	Easy9 Switch Disconnecter 2P 63A 400V	18
EZ9S16291	Easy9 Switch Disconnecter 2P 100A 400V	18
EZ9S16292	Easy9 Switch Disconnecter 2P 125A 400V	18
EZ9S16340	Easy9 Switch Disconnecter 3P 40A 400V	18
EZ9S16363	Easy9 Switch Disconnecter 3P 63A 400V	18
EZ9S16391	Easy9 Switch Disconnecter 3P 100A 400V	18
EZ9S16392	Easy9 Switch Disconnecter 3P 125A 400V	18
EZ9S16440	Easy9 Switch Disconnecter 4P 40A 400V	18
EZ9S16463	Easy9 Switch Disconnecter 4P 63A 400V	18
EZ9S16480	Easy9 Switch Disconnecter 4P 80A 400V	18
EZ9S16491	Easy9 Switch Disconnecter 4P 100A 400V	18
EZ9S16492	Easy9 Switch Disconnecter 4P 125A 400V	18
10387	comb busbar 1P 63 A 12 modules (18mm)	20
10388	comb busbar 1P 63 A 57 modules (18mm)	20
10389	comb busbar 2P 63 A 12 modules (18mm)	20
10390	comb busbar 2P 63 A 57 modules (18mm)	20
10391	comb busbar 3P 63 A 12 modules (18mm)	20
10392	comb busbar 3P 63 A 57 modules (18mm)	20
10393	comb busbar 4P 63 A 12 modules (18mm)	20
10394	comb busbar 4P 63 A 57 modules (18mm)	20
10395	comb busbar L1N/L2N/L3N 63 A 57 modules (18mm)	20
10397	1 set of 4, 35 mm ² connectors	20
10398	1 set of 10 bar end-pieces (2 phases)	20
10399	1 set of 10 bar end-pieces (3 phases)	20
10405	1 set of 10 bar end-pieces (4 phases)	20
10396	1 set of 10 tooth shields	20
EZ9ES6L	Easy9 DB 1P 6way fixed	21
EZ9ES8L	Easy9 DB 1P 8way fixed	21
EZ9ES10L	Easy9 DB 1P 10way fixed	21
EZ9ES12L	Easy9 DB 1P 12way fixed	21
EZ9ES16L	Easy9 DB 1P 16way fixed	21
EZ9ET12L	Easy9 DB 3P Straight 12 way Fixed Link - iSW Incomer	21
EZ9ET18L	Easy9 DB 3P Straight 18 way Fixed Link - iSW Incomer	21
EZ9ET24L	Easy9 DB 3P Straight 24 way Fixed Link - iSW Incomer	21
EZ9ET30L	Easy9 DB 3P Straight 30 way Fixed Link - iSW Incomer	21
EZ9ET36L	Easy9 DB 3P Straight 36 way Fixed Link - iSW Incomer	21
EZ9ET42L	Easy9 DB 3P Straight 42 way Fixed Link - iSW Incomer	21
EZ9ET12	Easy9 DB 3P 12 way Straight 4P RCCB / Dual Incomer	21
EZ9ET18	Easy9 DB 3P 18 way Straight 4P RCCB / Dual Incomer	21
EZ9ET24	Easy9 DB 3P 24 way Straight 4P RCCB / Dual Incomer	21
EZ9ET30	Easy9 DB 3P 30 way Straight 4P RCCB / Dual Incomer	21
EZ9ET36	Easy9 DB 3P 36 way Straight 4P RCCB / Dual Incomer	21
EZ9ET42	Easy9 DB 3P 42 way Straight 4P RCCB / Dual Incomer	21
EZ9EP66	Easy9 DB Split 6+6 ways	22
EZ9EP612	Easy9 DB Split 6+12 ways	22
EZ9EP1212	Easy9 DB Split 12+12 ways	22
EZ9EP1218	Easy9 DB Split 12+18 ways	22
EZ9EP1224	Easy9 DB Split 12+24 ways	22
EZ9EP1230	Easy9 DB Split 12+30 ways	22
EZ9EP1818	Easy9 DB Split 18+18 ways	22
EZ9EP1824	Easy9 DB Split 18+24 ways	22
EZ9R16F	Easy9 1 Row 16 module Flush	27
EZ9R216F	Easy9 2 Rows 16 module Flush	27
EZ9R316F	Easy9 3 Rows 16 module Flush	27
EZ9R416F	Easy9 4 Rows 16 module Flush	27
EZ9R516F	Easy9 5 Rows 16 module Flush	27
EZ9R616F	Easy9 6 Rows 16 module Flush	27

Notes

A series of horizontal dashed lines for writing notes, spanning most of the page width and covering the majority of the vertical space.

Become an energy champion today!

Because saving energy is everyone's business

- > Free Energy Efficiency courses for you and your staff
- > On-demand training takes less than an hour
- > More than 50,000 courses completed to date
- > Courses now available in multiple languages: Arabic, English, Chinese, Spanish, Italian, Russian, Brazilian Portuguese, German, Dutch, French, Japanese, Korean and Turkish.
- > More than 30,000 registered users from 120 plus countries



Enroll TODAY!

Classes are **FREE**, for a limited time only!
Visit www.MyEnergyUniversity.com
and enter the key code **32323P**

Stay connected all the time. Join us!

★ "Like" and "Follow" **Schneider Electric** on     
or visit www.schneider-electric.com/ae

Make the most of your energySM

Schneider Electric FZE

Level 2, Dubai Technology,
Entrepreneurship Centre (DTEC), Dubai, United Arab Emirates
Phone: + 971 (4) 709 91 00
Fax: + 971 (4) 709 91 01
www.se.com/ae



**Schneider Electric
Customer Care Center**

UAE/Pakistan/Yemen	+971 4 7099333
Bahrain	+973 1721 3277
Kuwait	+965 22494604
Oman	+968 80073666
Qatar	+974 44553010
Saudi Arabia	+966 9200 111 01
Fax	+971 4 7099399

E-mail: KSA.CCC@schneider-electric.com
ae-ccc-gulf@se.com
www.se.com/ae

Due to evolution of standards and equipment, the characteristics indicated in texts and images of this document do not constitute a commitment on our part without confirmation.

Designed by: Dax Gaudiel, Marketing Communications,
Schneider Electric Gulf